

Draw-wire system SZG81 - WDGA SSI



Typical areas of application include:

lift/elevators, lifting platforms, theatre stages, fork lifts and cranes.

Measurement ranges::

0 mm up to 2.500 mm, 0 mm up to 3.500 mm, 0 mm up to 5.000 mm and 0 mm up to 6.250 mm

Resolution measurement ranges WDGA58A:

Position per mm	Bit per revolution
1,26	8
2,52	9
5,04	10
10,08	11
20,17	12

Deviation: Less than 0.02 % of the final value.

Measuring wire: 0.86 mm of thick nylon coated high-grade steel wire.

Wire connection: eye
max. wire speed: 7.5 m/sec.
Pull out strength: approx. 0.5 kg

System-unit housing: anodised aluminum

Weight: SZG incl. encoder max. 2.5 kg

Life expectancy: At least 10 million cycles

Operating temperature: -40 °C up to +80 °C

Storage temperature: -40 °C up to +80 °C

Interface

SSI
Clock input: via opto-coupler
Clock frequency: 100 kHz up to 500 kHz up to 2 MHz on request
Data output: RS485/RS422 compatible
Output code: gray or binary
SSI output: Angular-/position value
Parity bit: optional (even/odd)
Error bit: optional
Turn on time: <1.5 s
Positive direction: DIR = +Ub ⇒ position configuration ~ length
Set to zero: Set: Preset = apply +Ub for 2 s
Deactivate: Preset = GND

Electrical Data:

Supply voltage: 10 VDC up to 30 VDC;
4.75 VDC up to 5.5 VDC
max. 80 mA
Power consumption: max. 0.8 W

Protocol SSI:

Single transmission

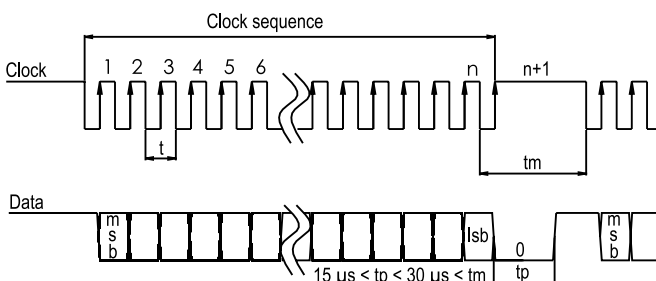

- Exceptionally rugged length sensor
- Measuring range: 0 mm bis 2.500 mm bis 0 mm bis 6.250 mm
- Interface: SSI
- IP65 absolute encoder WDGA SSI ready-mounted

www.wachendorff-automation.com/szg81wdgassi

The draw-wire encoder SZG81 WDGA SSI was developed for use in harsh environments. The various methods of installation mean high flexibility. It can be used even where space is tight, thanks to its compact dimensions. The SZG81 WDGA SSI can be mounted quickly and with its highly precise mechanics provides reliable accurate length measurement, with all advantages, which result from an absolute length measurement. e. g. The position-value is saved, if supply breaks down and is available immediately if supply gets recovered. Doing a reference run isn't necessary. The intelligent spring-suspension and the nylon-coated stainless-steel wire cable guarantee long-service life, even in difficult operating conditions. The encoder is already installed.

Multipath transmission

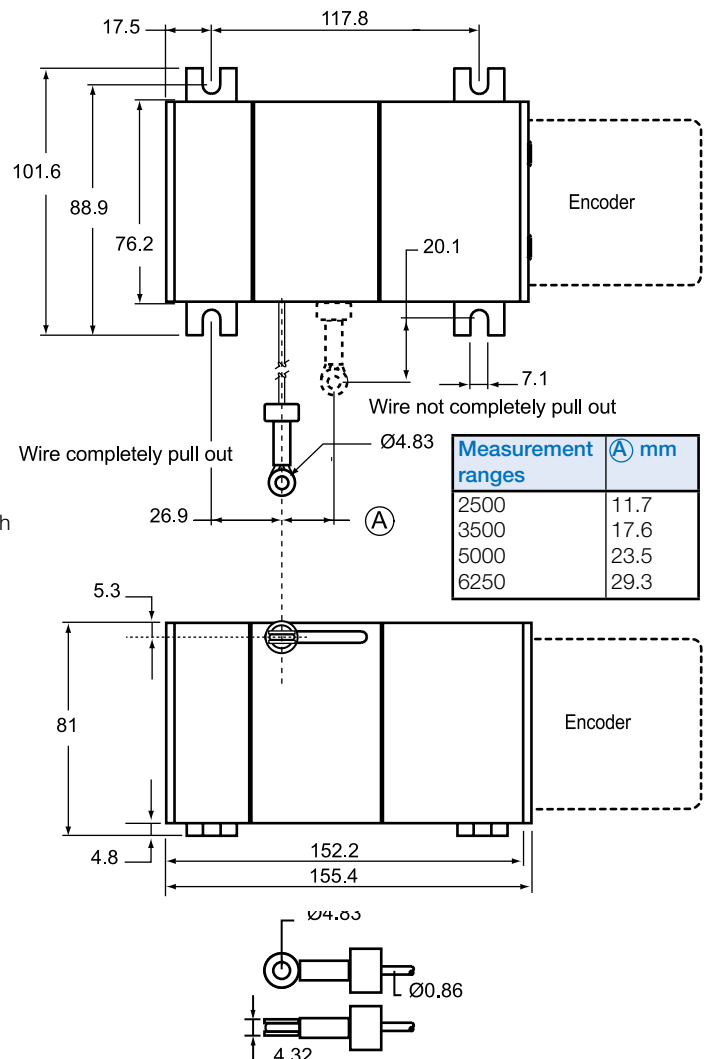
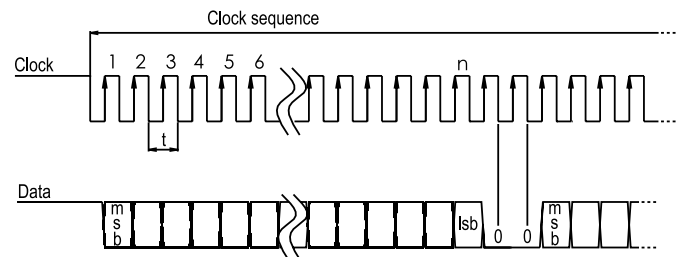

All details in mm and dependent on the encoder configuration.

Montageanleitung Absolutgeber WDGA EnDra® SSI,

Assembly instructions for WDGA EnDra® SSI absolute encoder, Instructions de montage, capteur angulaire WDGA EnDra® SSI, Istruzioni per l'uso trasduttore assoluto WDGA EnDra® SSI, Instrucciones de montaje codificador absoluto WDGA EnDra® SSI.

		-40 °C ... +80 °C (-40 °F ... +176 °F)	WDGA58V: -20 °C ... +80 °C (-4 °F ... 176 °F)
		-40 °C ... +100 °C (-40 °F ... +212 °F)	-20 °C ... +80 °C (-4 °F ... 176 °F)

Montage nur qualifiziertes Personal
 Assembly only qualified personnel
 Montage par un personnel qualifié
 Montaggio solo personale qualificato
 Montaje solamente personal cualificado

DIN EN 100015-1

Sicherheitsmassnahmen/safety instructions:
 Die Produkte dürfen nur in industrieller Umgebung und im NICHT sicherheitsrelevanten Bereich eingesetzt werden. The products are only designed and produced for use in industrial environments and NOT for use in safety related applications.

WDGA58B WDGA58S WDGA58V		M3 (8.8) Ma = 1 Nm
WDGA58A WDGA58B WDGA58S WDGA36A		M4 (8.8) Ma = 2 Nm

WDGA58A WDGA58B WDGA58S WDGA36A		M3 (8.8) Ma = 1 Nm M4 (8.8) Ma = 2 Nm
------------------------------------------	--	----------------------------------------------------

WDGA58A WDGA58B WDGA58S WDGA58V WDGA36A		M3 (8.8) Ma = 1 Nm	M4 (8.8) Ma = 2 Nm
-----------------------------------------------------	--	-----------------------	-----------------------

max. Kabellänge* max. cable length Longueur max du Câble Lunghezza massima Cable Longitud máx. de cable	Übertragungsrate Transmission rate Taux de transfert Velocità di trasferimento Velocidad de transmisión
20 m **	≤ 500 kHz
* 5 VDC max. 2 m ** >20 m auf Anfrage, on request, sur demande, su richiesta, a solicitud	

Ausgangsschaltung
 Output Circuit,
 Couplage de sortie,
 Circuito d'uscita,
 Circuito de salida
RS485

Eingangsschaltung, Input Circuit,
 Couplage d'entrée, circuito d'ingresso,
 Circuito de entrada

Einschaltzeit, System start-up Time,
 Temps de commutation, Tempo di commutazione,
 tiempo de conmutación: <1,5 s

Positive Zählrichtung: (Blick auf Welle)
 Complement = nc ⇔ cw
 Complement = +Ub ⇔ ccw
 Preset = +Ub für 2 s

Standard	F _r max.	F _a max.
WDGA58A WDGA58B Ø 6 mm Ø 10 mm	125 N 220 N	120 N 120 N
WDGA58S WDGA58V Ø 10 mm	100 N	100 N
WDGA36A	80 N	50 N
WDGA36E WDGA58E	80 N 80 N	50 N 50 N

WDGA36E **Artikelnr., Item number, Numéro d'article, Número de artículo :**
 WDGDS10016

d/mm	Lmin.	Lmax.	D	
WDGA 36E	6	8	17	42

M3 (8.8)
 Ma = 1 Nm



WDGA58E **Artikelnr., Item number, Numéro d'article, Número de artículo :**
 WDGDS10001

d/mm	Lmin	Lmax	D
6, 6.35 (1/4"), 7, 8, 9.525 (3/8"), 10, 12, 14	11	15	56

M5 (8.8), Ma=3Nm
 M3 (8.8), Ma=1Nm

	Stecker, connector, Fiche, Conector, spina			Kabel, cable, Câble, Cable, cavo	
	CB8/CC8 (M12, 8-pin)	C5 (M23 12-pin)	CH8 (M16 8-pin)	K1/K6 L2/L3	L3 58V
GND	1	12	2	wh	og
Plus U+	2	11	1	bn	bn
SSI CLK+	3	2	6	gn	gn
SSI CLK-	4	1	5	ye	ye
SSI DATA+	5	3	4	gy	gy
SSI DATA-	6	4	3	pk	pk
PRESET	7	9	8	bu	bu
DIR	8	8	7	rd	rd
Schirm Shield Ecran Pantalla Schermo	Gehäuse housing boîte carcasa contenitore	Gehäuse housing boîte carcasa contenitore	Gehäuse housing boîte carcasa contenitore	K1,K6: offen, open, ouvert, aperto, abierto L2/L3: Gehäuse, housing, boîte, carcasa, contenitore	

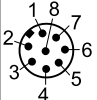
Connection configuration for encoder WDGA 58A SSI:

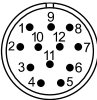
				
Connector/cable	M12 x1	M16	M23	cable outlet
Description	CB8 axial, CC8 radial, 8-pin	CH8 radial, 8-pin	C5 radial, 12-pin	K1, radial L2, axial L3, radial
GND	1	2	12	wh
Plus U+	2	1	11	bn
SSI CLK+	3	6	2	gn
SSI CLK-	4	5	1	ye
SSI DATA+	5	4	3	gy
SSI DATA-	6	3	4	pk
PRESET	7	8	9	bu
DIR	8	7	8	rd
Shield	housing	housing	housing	housing K1: n. c.

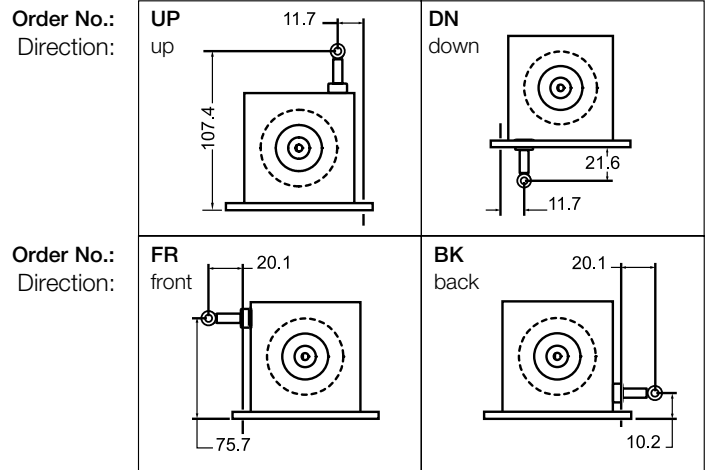

Ordering information:

Measurement range:
2500 = 2,500 mm
3500 = 3,500 mm
5000 = 5,000 mm
6250 = 6,250 mm

Measurement wire:
N = 0.86 mm of thick nylon coated high-grade steel wire

Mounting direction:
UP = Wire exit up
DN = Wire exit down
FR = Wire exit front
BK = Wire exit back

Singleturn resolution in bit per revolution
08 => 8 bit (= approx. 1.26 position/mm)
09 => 9 bit (= approx. 2.52 position/mm)
10 => 10 bit (= approx. 5.04 position/mm)
11 => 11 bit (= approx. 10.08 position/mm)
12 => 12 bit (= approx. 20.17 position/mm)

Multiturn resolution
18 (example) = 6 bit up to 24 bit

Interface
SI = SSI

Software:
A = up to date release

Code
B = binär
G = gray

Power supply
0 = 10 V up to 30 V
1 = 4,75 V up to 5,5 V

Galvanic isolation
1 = yes

Connection cable:
(K1= Schirm offen, L2, L3 = Schirm mit Gebergehäuse verbunden)
K1 = radial, with 2 m cable, IP40
L2 = axial, with 2 m cable, IP65
L3 = radial, with 2 m cable, IP65
connector:
CB8 = M12 x 1, 8-polig, axial
CC8 = M12 x 1, 8-polig, radial
CH8 = M16, 8-polig, radial
C5 = M23, 12-polig, radial

Your draw-wire system